

# DeltaV SIS™ Safety Network Components



DeltaV SIS Smart Switches



LSNB

The safety network components are based on standard Ethernet technology and are dedicated to the DeltaV SIS.

- Dedicated to safety – no possibility of common-cause control and safety communication failures
- Required update time supported on the DeltaV SIS™ local safety network
- Scalable and cost-effective
- Fully redundant networks

## Introduction

The local safety network (LSN) is the communication backbone of the DeltaV SIS™ process safety system. The LSN is a standard Ethernet network dedicated to the DeltaV SIS system that enables communication between CHARMs smart logic solvers (CSLS) and a single SZ controller. The CSLs communicate secure parameters and input data to other CSLs over the LSN.

SZ controllers connect to both the area control network and the LSN to isolate the CSLs from the process control system.

Starting with v13 and later, the global safety network (GSN) enable safety-rated communication among LSNs while allowing functional segregation on different LSNs. A typical example is separation of fire and gas (F&G) and emergency shutdown (ESD) applications over separate LSNs while allowing safe and secure communication across both applications. Starting with v14.3.1, the GSN can be logically separated in domains which are a group of LSNs.

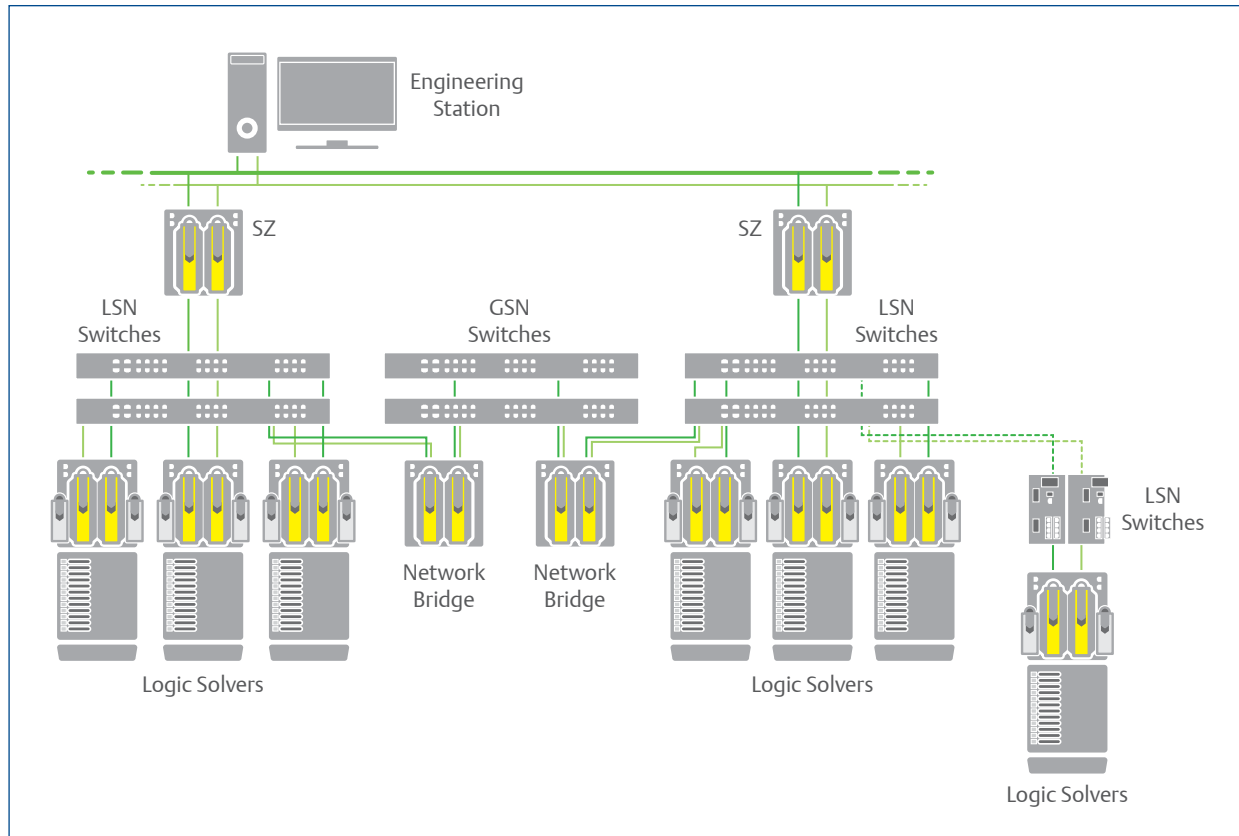

*DeltaV SIS safety network architecture diagram.*

## Benefits

**Dedicated to safety.** Some systems from other vendors use the same networks for both control and safety. The DeltaV SIS LSN and GSN are dedicated to safety, carrying only safety-rated signals and isolated from the control network. They are therefore immune to any failure of the control network.

**Fifty millisecond update time.** All the data broadcast on the LSN is available to every CSLS on the same LSN every 50 milliseconds. Combined with the speed of the CSLS, the 50 millisecond update time guarantees input-to-output time of less than 300 milliseconds anywhere on the LSN when the CSLS is configured for 50-millisecond scan rate.

**Plug-and-play components.** As a dedicated safety network with predictable communications traffic, Emerson has done all of the system testing so you only have to plug the components together to create the safety networks.

**Standards compliance.** Network components are compliant with standards such as IEEE, CE, and CSA.

**Network diagnostics.** The Light Emitting Diodes (LED) on each switch provide health status information.

**Scalable in small increments.** You can expand the system readily and economically by adding hardware incrementally to your system. Just plug another CSLS into the LSN and it is recognized by the system. Online addition of new CSLSs will not interrupt your process.

**Fully redundant communications.** The safety networks are fully redundant communication networks. The carriers for all nodes have redundant safety network ports for communication with primary and secondary network connections.

## LSN Description and Specification

The SZ controllers and CSLs can be physically connected as a star topology (the LSN does not support network ring topologies).

Starting with DeltaV SIS v13, the LSN Bridge (LSNB) allows communication across multiple LSNs. The LSNB connect to the LSN following a star topology.

Refer to the latest DeltaV SIS Installation and Planning Guide for details of network layouts and network cable shielding requirements and power and grounding requirements for the overall DeltaV SIS system.

### For Use in Safety Integrity Level (SIL) 3 Applications

The LSN is certified for use in SIL 3 applications.

#### Wiring

The LSN requires the use of Category 5e screened (ScTP) cable for the 100/1000 BaseT/TX safety network.

The maximum twisted-pair cable length for the LSN for any device is 100 meters (328 feet).

The CSLs, LSNB, and SZ controller carriers contain Ethernet ports to provide the redundant communication for the LSN.

#### Fiber optic Wiring

Safety network ports (SNP) on the CLS are available for copper only. DeltaV SIS Smart Switches can be connected using fiber optic cables.

Because fiber optic cables do not conduct electricity, they should be used in connections between buildings or in plant areas where electromagnetic interference is present.

Fiber optic cabling must be used where cable runs are longer than 100 meters (328 ft.).

#### LSN Hardware Includes:

- DeltaV SIS Smart Switches
- Ethernet Isolation Ports on the SZ controller carrier
- SNPs on the CSLs carrier
- LSNB to communicate with other LSNs through a GSN.

A redundant CSLs communicates over the LSN with up to 15 other CSLs, 1 SZ controller, and 1 LSNB allowing great flexibility and ease of system expansion.

*Only DeltaV SIS Smart Switches* are supported on the LSN.

## GSN Description and Specification

Multiple LSNs can be connected using LSNBs. The LSNBs are physically connected as a star topology (GSN does not support network ring topologies). Starting with v14.3.1 and later, the GSN can be logically separated in domains. A GSN domain is a logical group of LSNs.

Refer to the latest DeltaV SIS Installation and Planning Guide for details of network layouts and network cable shielding requirements and power and grounding requirements for the overall DeltaV SIS system.

### For Use in SIL 3 Applications

The GSN is certified for use in SIL 3 applications.

#### Wiring

The GSN requires the use of ScTP cable for the 100/1000 BaseT/TX safety network.

The maximum twisted-pair cable length for the GSN for any LSNB is 100 meters (328 feet).

The LSNB contains Ethernet ports to provide the redundant communication for both the LSN and GSN.

#### Fiber optic Wiring

Ethernet on the LSNB carrier are available for copper only. DeltaV SIS Smart Switches can be connected using fiber optic cables.

Because fiber optic cables do not conduct electricity, they should be used in connections between buildings or in plant areas where electromagnetic interference is present.

Fiber optic cabling must be used where cable runs are longer than 100 meters (328 ft.).

#### GSN Hardware Includes:

- DeltaV SIS Smart Switches
- LSNBs to communicate with other LSNs throughout the GSN.

LSNB communicates over the GSN with other LSNBs, allowing great flexibility and ease of system expansion. Up to 16 LSNBs can publish safety data into one GSN domain but the maximum number of LSNBs publishing information depends on amount of data published by each LSNB. There is no limit for the number of LSNBs subscribing to information from the GSN. Prior v14.3.1, only one domain was supported within the GSN, starting v14.3.1 and later, up to 16 domains are supported within the GSN. Refer to Books Online for more information about system capacities.

Only DeltaV SIS Smart Switches are supported on the GSN. The GSN requires DeltaV SIS Smart Switches with software release 4.2.14 or greater.

### DeltaV SIS Smart Switches

The DeltaV SIS Smart switches are “built-for-purpose” switches with DeltaV SIS specific software and features to make them plug-and-play in the safety network.

DeltaV SIS Smart Switches require no configuration to function on the safety network.

**DeltaV SIS Smart Switches are the only supported switch to be used within the LSN and GSN.** DeltaV SIS Smart Switches are different than DeltaV Smart switches (non-SIS) and are not interchangeable.

### DeltaV SIS Smart Switch Specifications

Ambient Conditions	SS6041F01C1 SS6041F05C1 SS6041F06C1 DIN Rail Mount	SS6041F01C2 SS6041F05C2 SS6041F06C2 DIN Rail Mount	SS6048R2P(1-4) Rack Mount Switches
Operating Temperature	0° to +60°C	-40° to +70°C	0° to +50°C
Storage/Transport Temperature	-40° to +70°C	-40° to +70°C	-20° to +85°C
Relative Humidity (Non-Condensing)	10% to 95%	10% to 95%	10% to 95%
Conformal-Coated	No	Yes	No
Harsh Area Rating	G2	G2 (conformal coating allows switch to be used in G3 environments but switch is not certified to G3)	G2
<b>Mechanical stability – All switches:</b> IEC 60068-2-27 shock 15 g, 11 ms duration, 18 shocks IEC 60068-2-6 vibration 1 mm, 2 Hz - 13.2 Hz, 90 min.; 0.7g, 13,2 Hz - 100 Hz, 90 min.; 3.5 mm, 3 Hz - 9Hz, 10 cycles, 1 octave/min.; 1g, 9 Hz - 150 Hz, 10 cycles, 1 octave/min.			
<b>EMC emitted immunity:</b> FCC CFR47 Part 15 FCC CFR47 Part 15 EN 55022 EN 55022 Class A			
<b>EMC interference immunity SS6041F0(1,5,6) DIN rail switches:</b> EN 61000-4-2 electrostatic discharge (ESD) 6 kV contact discharge, 8kV air discharge EN 61000-4-3 electromagnetic field 10 V/m (80 - 1000 MHz) EN 61000-4-4 fast transients (burst) 2 kV power line, 1 kV data line EN 61000-4-5 surge voltage power line: 2kV (line/earth), 1kV (line/line), 1kV data line EN 61000-4-6 conducted immunity 3 V (10 kHz - 150 kHz), 10 V (150 kHz - 80 MHz)			
<b>EMC interference immunity: SS6048R2P(1-4) Rack mount switches:</b> EN 61000-4-2 electrostatic discharge (ESD) 4 kV contact discharge, 8kV air discharge EN 61000-4-3 electromagnetic field 10 V/m (80 - 2700 MHz) EN 61000-4-4 fast transients (burst) 2 kV power line, 4 kV data line EN 61000-4-5 surge voltage power line: 2kV (line/earth), 1kV (line/line), 4kV data line EN 61000-4-6 conducted immunity 10 V (150 kHz - 80 MHz)			

### General Specifications for the SS6041F01, SS6041F05, and SS6041F06 DeltaV SIS Smart Switches

**Power requirements:**

Operating voltage: 24 V DC (18-30) V

**Mechanical construction:**

Dimensions MM (W x H x D) 74 x 131 x 111 (2.9 x 5.16 x 4.37 in)

Mounting DIN Rail

Weight 410 g (14.48 oz) (All models)

Protection class IP20

Provided in SS# - qty 1 FP20 switch with terminal block.



**PRODUCT NOTE:** These switches are described as supporting local ports and uplink ports. Local ports are connected to a single device such as a SZ Controller or CSLS. An uplink port is connected to another switch. There is no difference in the way the ports function, and a port designated as an “uplink port” can be used as a local port.

### General Specifications for the SS6048R2P(1-4) DeltaV SIS Smart Switches

Up to 26 port Fast Ethernet/Gigabit Ethernet Industrial Workgroup Switch.



Ports available:

Base module has 10 ports -- 2 uplink ports (10/100/1000 wired or using VE6050 SFP modules) and 8 TX ports (10/100 Base-TX) in a fixed configuration.

Up to 16 additional 100Mb ports using the SS6049 - 8 port Media Modules in any combination – TX, MM fiber, SM fiber, or 100Mb SFP transceivers.

**Power supply/signaling contact:** 1 x plug-in terminal block, 2-pin, output manual or automatic switchable (max. 1 A, 24 V DC respectively 24 V AC)

**V.24 interface:** 1 x RJ11 socket, serial interface for troubleshooting

**USB interface:** For flash upgrade of switch software

**Network size - length of cable – base module:**

Twisted pair (TP)- 8 TX port base module and wired 10/100/1000 ports: 0 – 100m

SFP module ports: Supports any combination of VE6050 1Gb or 100FX Transceivers

**Smart Switch “Stacking” Support:** SS6048 switches do not support “stacking”. To create a central switch(s) of greater than 24 ports switches should be interconnected using the front panel gigabit ports

**Power requirements:**

Operating voltage 100 - 240 VAC, 47 - 63 Hz

Rated Current 0.4 – 0.2 A

Power output in Btu (IT) h –41 (without media modules)

Power consumption 12 W (without media modules)

**Mechanical construction:**

Dimensions 448 x 310 x 44 (without mounting bracket)

Mounting 19" control cabinet





Weight 3.60 kg

Protection class IP20

Provided SS60 device, terminal block for signal contact, 2 brackets with fastening screws (pre-assembled), and housing feet - stick-on, power cable.

**Order separately:** Expansion modules, Fast Ethernet SFP modules, Gigabit Ethernet SFP modules. Expansion modules SS6049M01, SS6049M02, SS6049M03, and SS6049M04 can be used with SS6048-series DeltaV SIS Smart switches.

When rail mounted these switches require additional mounting supports in addition to 19" rail mounting brackets

Specifications for SS6049 Expansion Modules				
				
	Specifications for SS6049M01	Specifications for SS6049M02	Specifications for SS6049M03	Specifications for SS6049M04
Length of cable	100m	See fiber cable specs	See fiber cable specs	See fiber cable specs
<b>Power requirements:</b> Current consumption Power output in Btu(IT) h	2 W 7	10 W 7	10 W 7	11 W 7 including SFP modules
<b>Mechanical constructions:</b> Dimensions MM (W x H x D) Weight Protection class	138 x 90 x 42 0.21 Kg IP 20	138 x 90 x 42 0.18 Kg IP 20	138 x 90 x 42 0.18 Kg IP 20	138 x 90 x 42 0.13 Kg IP 20

### Fiberoptic Cable Specifications – Apply to All DeltaV SIS Smart Switch Models

Fiberoptic Cable Types	Specifications Specifications apply to all fiber connections on any model of DeltaV SIS Smart Switches <i>Actual fiberoptic distances achieved depend on the fiber type used and other components installed on the network such as splices and patch panels that can reduce Fiberoptic signal strength.</i>
Multimode fiber (MM) 50/125 μm	0 - 5000 m, 8 dB link budget at 1300 nm, A = 1 d/km, 3 dB reserve, B = 800 MHz x km
Multimode fiber (MM) 62.5/125 μm	0 - 4000 m, 11 dB link budget at 1300 nm, A = 1 dB/km, 3 dB reserve, B = 500MHz x km
Single mode fiber (SM) 9/125 μm	0 – 32.5 km, 16 dB link budget at 1300 nm, A = 0,4 dB/km, 3 dB reserve, D = 3,5ps/(nm x km)
Single mode fiber (LH) 9/125 μm (long haul transceiver):	24 – 86.6 km, 7 - 29 dB link budget at 1550 nm, A = 0,3 dB/km, 3 dB reserve, D = 19 ps/(nm x km)

## DeltaV SIS Smart Switch Certifications

Declaration/ Approval	FP20 SS6041	FP20-ES SS6041	RM100 SS6048
<b>CE Declaration – Basic Standards</b> EMC (Harmonized European Standards according to EMC-Directive 2004/108/EC) <ul style="list-style-type: none"> <li>- EN 55022 Emission of ITE</li> <li>- IEC/EN 61000-6-2:2005 – Immunity in industrial environment</li> <li>- EN 61000-3-2:2000 + A2:2005 – Limits for harmonic current emissions</li> <li>- EN 61000-3-3:1995 + A1:2001 – Limitation of voltage changes, voltage fluctuations and flicker Safety (Harmonized European Standards according to Low-Voltage-Directive 2006/95/EG)</li> <li>- EN 61131-2:2003 – Programmable Controllers</li> </ul>	Class A	Class A	Class A
<b>FCC Declaration</b> <ul style="list-style-type: none"> <li>- CFR47: 2005, Part 15</li> </ul>	Class A	Class A	Class A
<b>cUL Approval according to UL 508</b> <ul style="list-style-type: none"> <li>- UL 508:2003 – Industrial control equipment – US. Safety standard</li> <li>- CSA 22.2 No. 142-M1997 – Industrial control equipment – Canadian safety standard</li> </ul>	Yes	Yes	Yes
<b>cUL Approval according to ISA-12.12.-01 Class 1 Div. 2 /UL1604</b> <ul style="list-style-type: none"> <li>- ANSI/ISA 12.12.01:2000, Approved 2001</li> <li>- CSA 22.2 No. 213-M1987</li> </ul>	Yes	Yes	N/A
<b>IEC/EN 61131-2 Declaration</b> <ul style="list-style-type: none"> <li>- EN 61131-2 : 2003 – Programmable Controllers</li> </ul>	Yes	Yes	N/A
<b>IEC/EN 61850-3 Declaration</b> <ul style="list-style-type: none"> <li>- EN 61850-3 :2002 – Communication Networks and Systems in Substations (environmental requirements)</li> </ul>	Yes	Yes	N/A
<b>cUL Approval according to UL 60950-1</b> <ul style="list-style-type: none"> <li>- UL 60950-1:2003 – Safety of Information Technology Equipment – US. Safety standard</li> <li>- CSA 22.2 No. 950:1998 – Safety of Information Technology Equipment – Canadian safety standard</li> </ul>	N/A	N/A	Yes
<b>IEC/EN 60950-1 Certification according to CB-scheme</b> <ul style="list-style-type: none"> <li>- EN 60950-1:2003 – Information technology equipment – Safety</li> </ul>	N/A	N/A	Yes
<b>ATEX 100a Approval, Zone 2,</b> <ul style="list-style-type: none"> <li>- according to EN 60079-15:2005 – Electrical apparatus for explosive atmospheres</li> </ul>	N/A	Yes	N/A
<b>GL (Germanischer Lloyd)</b>	Yes	Yes	N/A
<b>C-TICK (Australia)</b>	Yes	Yes	Yes
<b>GOST-R (Russia)</b>	Yes	Yes	Yes



## LSNB

Beginning with DeltaV v13, a LSNB can be installed on two or more LSNs, so multiple LSNs may be connected over a GSN.

DeltaV SIS Smart Switches require no configuration to function on the safety networks. However, to support GSN functionality the DeltaV SIS Smart Switch must have software v4.2.14 or later.

**DeltaV SIS Smart Switches are the only supported switches to be used within the LSN and GSN.**

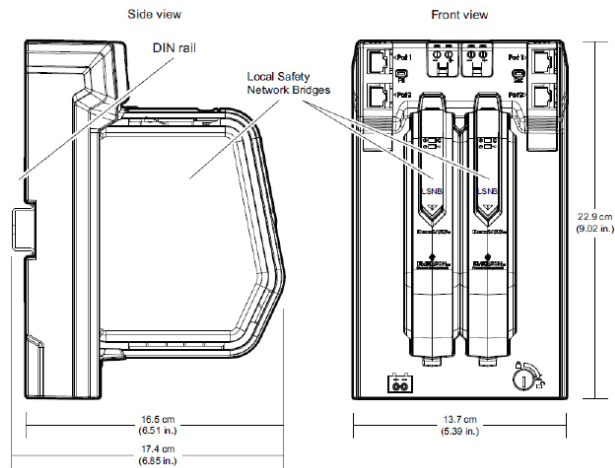

LSNB shown on Dual Universal Safety Carrier.

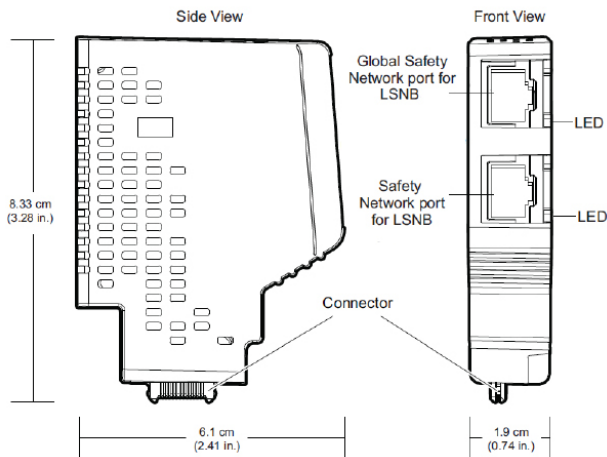

LSNB Ethernet Isolation Port.



## LSNB Specifications

### Hardware

Specifications for Dual Universal Safety Carrier	
Capacity	Redundant LSNBs
Input power	+24 V DC $\pm$ 10% at 1 A maximum
Battery power	+5.0 to +12.6 V DC at 30 $\mu$ A typical
Redundant Ethernet connections through replaceable Ethernet Isolation Ports (EIPs)	Copper twisted pair: 10/100BASE-TX with RJ45 connectors; Full duplex operation - 100 m distance
Mounting	DIN rail latch to horizontally orientated T-type rail
Specifications for LSNB	
Number of GSNs per system	One GSN per system. Up to 16 LSNBs per domain can publish information to the GSN. There is no limit for the number of LSNBs subscribing to information from the GSN.
Input power	+24 V DC $\pm$ 10% at 575 mA maximum for redundant
Heat dissipation (redundant)	13 Watts maximum for redundant
Mounting	Slots on the Dual Universal Safety Carrier
Communication	Redundant Ethernet connections through Dual Universal Safety Carrier to the : a) LSN b) GSN
LED Indicators	
Green – Power	Indicates DC power is applied.
Red – Error	Indicates an error condition or unassigned LSNB.
Green – Active/Standby	Indicates operating mode of each LSNB.

## Certifications LSNB

The following certifications are available for the LSNB:

- **CE:**
  - EMC- EN 61326-1
- **FM:**
  - FM 3600
  - FM 3611
  - FM 3810
- **CSA:**
  - CSA C22.2 No. 213-M1987
  - CSA C22.2 No. 1010-1
- **ATEX:**
  - ATEX 94/9/EC
  - EN60079-0
  - EN60079-15
- **IEC-Ex:**
  - EN60079-0
  - EN60079-15
- **Marine Certifications:**
  - IACS E10
    - ABS Certificate of Design Assessment
    - DNV-GL Marine Certificate

## Hazardous Area/Location:

The LSNB can be installed and used based on the following Standards:

- **FM (USA):**
  - Class I, Division 2, Groups A, B, C, D, T4
- **cFM (Canada):**
  - Class I, Division 2, Groups A, B, C, D, T4
- **ATEX:**
  -  Ex nA IIC T4 Gc
- **IEC-Ex:**
  - Ex nA IIC T4 Gc

## System Compatibility

DeltaV SIS LSN requires:

- v12.3 DeltaV SIS or later software
- SZ Controllers
- CSLSs
- DeltaV SIS Smart Switches (these switches are the ONLY switches allowed to be used in the LSN)









DeltaV SIS GSN requires:

- v13.3 DeltaV SIS or later software for a single GSN domain, v14.3.1 or later is required for multiple GSN domains
- LSNBs
- DeltaV SIS Smart Switches with software release 4.2.14 or greater (these switches are the ONLY switches allowed to be used in the GSN)

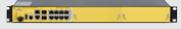
DeltaV Smart switches (non-SIS) cannot be used for LSN or GSN communication since the configuration of these switches will interfere with the proper operation of the LSN and GSN and block LSN/GSN communications. When connecting a SZ controller with more than one CSLS, it is always required to use a DeltaV SIS Smart Switch.

When mounting the CSLS in a hazardous area field enclosure where a fiber to copper converter is required, the standard VE6060 and VE6061 DeltaV Media Converters should be used. These Media Converters are certified for installation in hazardous areas up to a classification of Zone 2 or Class 1 Div 2 and are supported for hazardous area field enclosures for the LSN and GSN. For more information about DeltaV media converter, consult the Product Data Sheet **DeltaV Media Converters**.

## Ordering Information

DeltaV SIS Smart Switches	Model Number
The modules with SS# ending in C2 are extended spec versions of the switches and must be used where high temperature or conformal coating is required	
<p><b>8 ports – all copper</b> Smart 6-port (RJ45) 10/100BASE-TX Switch with two RJ45 10/100BASE-TX Uplink Ports (FP20-6TX2TX) Current consumption at 24 V DC 221 mA Power output in Btu (IT) h 18.1</p>	<p>SS6041F01C1 SS6041F01C2</p> 
<p><b>8 ports – 6 copper – 2 100MB Multi-Mode fiber</b> Smart 6-port (RJ45) 10/100BASE-TX Switch with two SC 100BASE-FX Multimode Uplink Ports (FP20-6TX2MM) Current consumption at 24 V DC 321 mA Power output in Btu (IT) h 26.3</p>	<p>SS6041F05C1 SS6041F05C2</p> 
<p><b>8 ports – 6 copper – 2 100MB Single-Mode fiber</b> Smart 6-port (RJ45) 10/100BASE-TX Switch with two SC 100BASE-FX Single Mode Uplink Ports (FP20-6TX2SM) Current consumption at 24 V DC 321 mA Power output in Btu (IT) h 26.3</p>	<p>SS6041F06C1 SS6041F06C2</p> 
<p><b>Smart 8-port Switch;</b> Each port is 10/100BASE-TX Copper RJ45; Includes two RJ45 Uplink ports and two slots for VE6050-series Transceiver Modules; Includes two expansion bays to add ports; redundant power supplies, with separate redundant power cabling; Redundant Power Supply; North American Power Cord (RM100 -Base Module) <b>Power requirements</b> Power output in Btu (IT) h 41 (without media modules) Power consumption 12 W (without media modules) Weight 3.60Kg (without media modules)</p>	<p>SS6048R2P1</p> 
<b>Smart 8-port Switch;</b> Australian Power Cord	SS6048R2P2
<b>Smart 8-port Switch;</b> European Power Cord	SS6048R2P3
<b>Smart 8-port Switch;</b> United Kingdom Power Cord	SS6048R2P4
<b>8-port Expansion Module</b> for SS6048-series DeltaV SIS Smart Switches; each Port is 10/100BASE-TX Copper RJ45 (RM100-EM8TX). See specifications in table below. Module is hot swappable	<p>SS6049M01</p> 
<b>8-port Expansion Module</b> for SS6048-series DeltaV SIS Smart Switches; each Port is 100BASE-FX Fiberoptic Multi-Mode SC (RM100-EM8MMFX). See specifications in table below. Module is hot swappable	<p>SS6049M02</p> 
<b>8-port Expansion Module</b> for SS6048-series DeltaV SIS Smart Switches; each Port is 100BASE-FX Fiberoptic Single-Mode SC (RM100-EM8SMFX). See specifications in table below. Module is hot swappable	<p>SS6049M03</p> 
<b>8-port Expansion Module</b> for SS6048-series DeltaV SIS Smart Switches. The slots can have any combination of VE6050-series 100Mb Transceivers installed. (RM100-EM8SFP). See specifications in table below. Module is hot swappable and SPF transceivers can be installed and removed under power.	<p>SS6049M04</p> 
<p><b>Smart Switch Security Plugs and Key; Package of 10 plugs and 1 key</b> <i>Note: DeltaV SIS Smart Switches come with plugs and the required tool. Additional plugs can be ordered using this model number. All unused ports shall be blocked with the port plugs.</i></p>	<p>SS6049</p> 

**Fiber optic SFP Transceivers for Use in DeltaV SIS Smart Switches:**

The Gigabit transceivers can be used only in the Gigabit ports of SS6048 switches.









The 100Mb transceivers can be used in the Uplink ports of the SS6048 switch and the SS6094 SFP expansion module of the SS6048.

All Transceivers except the VE6050T01 are compatible with the Extended Spec DeltaV SIS switches and can also be used in the standard spec DeltaV SIS switches as well.

Power Consumption for all Transceivers: Operating voltage power supply through the switch

- Power consumption 1 W
- Weight 40 g

DeltaV SIS Smart Switches must use the transceivers below. The switches are not compatible with other brands of transceivers. Cisco transceivers are not compatible with DeltaV Smart Switches.

Description	Model Number
Transceiver for DeltaV SIS Smart Switches; 1 Gigabit Ethernet; Single Mode Long Haul, for up to 120 Kilometers of fiberoptic cable (M-SFP-LH+/LC) [This SFP Module is not compatible with Extended Spec usage—not available with extended temperature specifications	VE6050T01 <i>Gigabit</i> 
Transceiver for DeltaV SIS Smart Switches; 1 Gigabit Ethernet; Single Mode Long Haul, for up to 80 Kilometers of fiberoptic cable (M-SFP-LH/LC-EEC) Extended Specs	VE6050T02 <i>Gigabit</i> 
Transceiver for DeltaV SIS Smart Switches; 1 Gigabit Ethernet; Single Mode, for up to 20 Kilometers of fiberoptic cable (M-SFP-LX/LC EEC) Extended Specs	VE6050T03 <i>Gigabit</i> 
Transceiver for DeltaV SIS Smart Switches; 1 Gigabit Ethernet; Multi-mode, for up to 550 meters of fiberoptic cable (M-SFP-SX/LC EEC) Extended Specs	VE6050T07 <i>Gigabit</i> 
Transceiver for DeltaV SIS Smart Switches; 100 Megabit Ethernet, Single Mode, for up to 100 Kilometers of fiberoptic cable (M-FAST SFP-LH/LC-EEC) Extended Specs	VE6050T04 
Transceiver for DeltaV SIS Smart Switches; 100 Megabit Ethernet; Single Mode, for up to 65 Kilometers of fiberoptic cable (M-FAST SFP-SM+/LC-EEC) Extended Specs	VE6050T05 
Transceiver for DeltaV SIS Smart Switches; 100 Megabit Ethernet; Single Mode, for up to 25 Kilometers of fiberoptic cable (M-FAST SFP-SM/LC-EEC) Extended Specs	VE6050T06 
Transceiver for DeltaV SIS Smart Switches; 100 Megabit Ethernet: Multi-Mode; for up to 5 Kilometers of fiberoptic cable (M-FAST SFP-MM/LC-EEC) Extended Specs	VE6050T08 

## Ordering Information LSNB

Description	Model Number
Redundant LSNB Assembly (Includes 2 LSNBs, Dual Universal Safety Carrier, 2 Ethernet Isolation Ports for twisted cooper, 2 power plugs)	SS3101

## Spare Part Ordering Information

Description	Model Number
Set of 2 Replacement Keys for Keylock Switch on SZ, CSLS, and Dual Universal Safety Carrier	SS6201

## Prerequisites

- DeltaV SIS Electronic Marshalling hardware requires DeltaV v12.3.x or later software.
- Only DeltaV SIS Smart Switches are supported on both the LSN and GSN.
- GSN hardware requires DeltaV v13.3.x or later software.
- Multiple GSN domains requires DeltaV v14.3.1 or later software.
- GSN requires DeltaV SIS Smart Switches with software release v4.2.14 or greater.

### Emerson

#### North America, Latin America:

+1 800 833 8314 or  
+1 512 832 3774

#### Asia Pacific:

+65 6777 8211

#### Europe, Middle East:

+41 41 768 6111

[www.emerson.com/deltavis](http://www.emerson.com/deltavis)

©2019, Emerson. All rights reserved.

The Emerson logo is a trademark and service mark of Emerson Electric Co. The DeltaV logo is a mark of one of the Emerson family of companies. All other marks are the property of their respective owners.

The contents of this publication are presented for informational purposes only, and while diligent efforts were made to ensure their accuracy, they are not to be construed as warranties or guarantees, express or implied, regarding the products or services described herein or their use or applicability. All sales are governed by our terms and conditions, which are available on request. We reserve the right to modify or improve the designs or specifications of our products at any time without notice.